

Profine[®]
water filter cartridges

ZERO

INSTALLATIONS- & BRUKSANVISNING

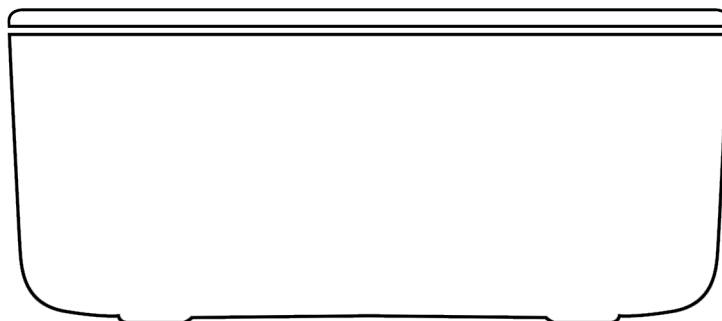

OBS!

Denna utrustning kräver regelbundet underhåll för att säkerställa kapacitet och reningsförmåga. Läs och använd produkten enligt denna anvisning.



CE



design odo fioravanti

PATENTED
MADE IN ITALY



MÅTT

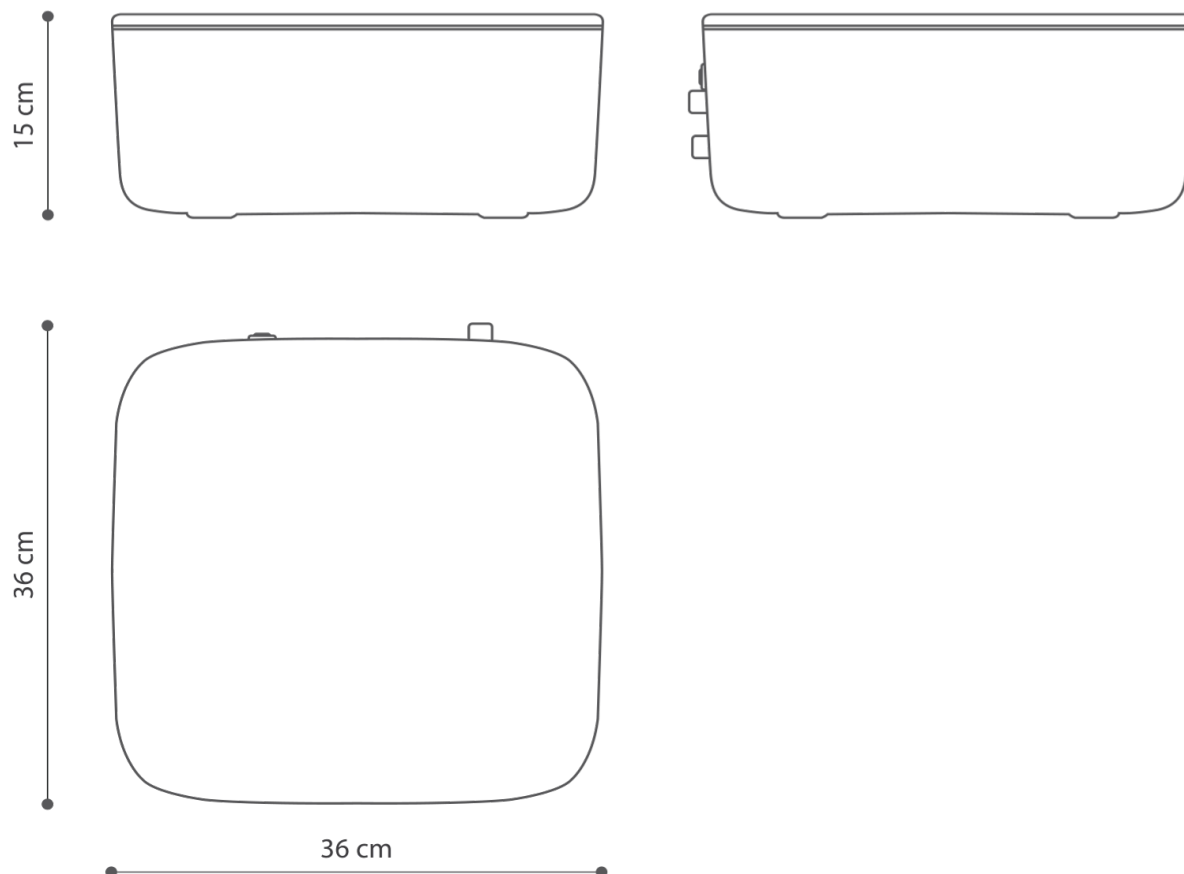

PAKETETS INNEHÅLL

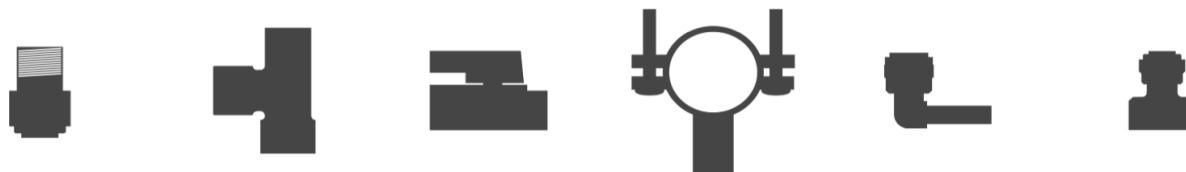

Utvändig rak koppling	T-koppling	Kulventil	Dräneringsklämma	Armbågskoppling 8 mm	Invändig rak koppling
1 st	1 st	1 st	1 st	2 st	2 st
9300258	9400334	9400300	1100137	9300735	9300734



Slang 8,6 mm	Slang ¼"	Armbågskoppling ¼"	Invändig rak koppling	O-ring 3021	Kran, kit
2 m	1 m	1 st	1 st	1 st	1 st
9300733	9300522	9300728	9300651	1100223	XO0001BTW



INSTALLATIONSRIKTNING

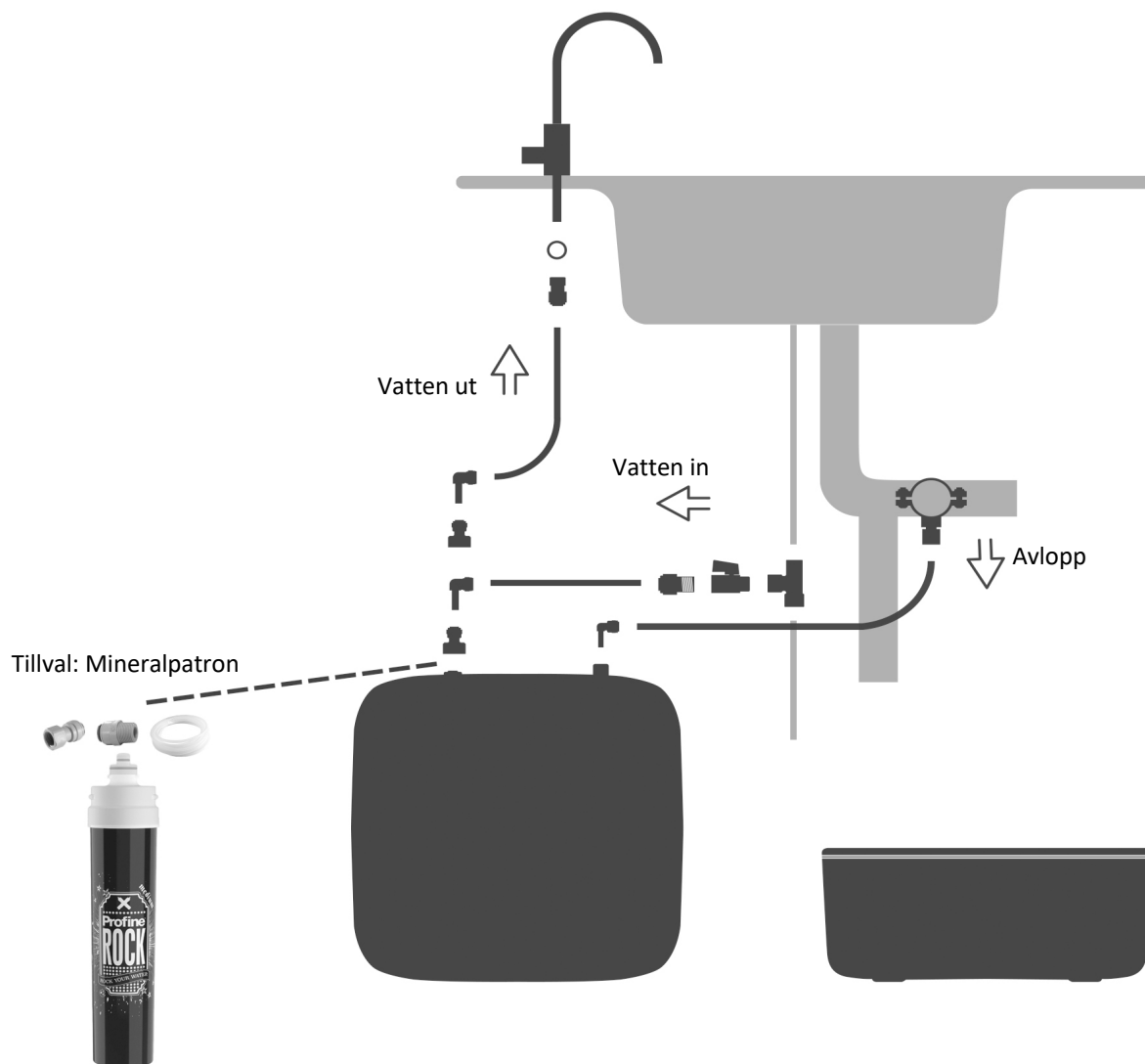

PLACERING AV ENHET

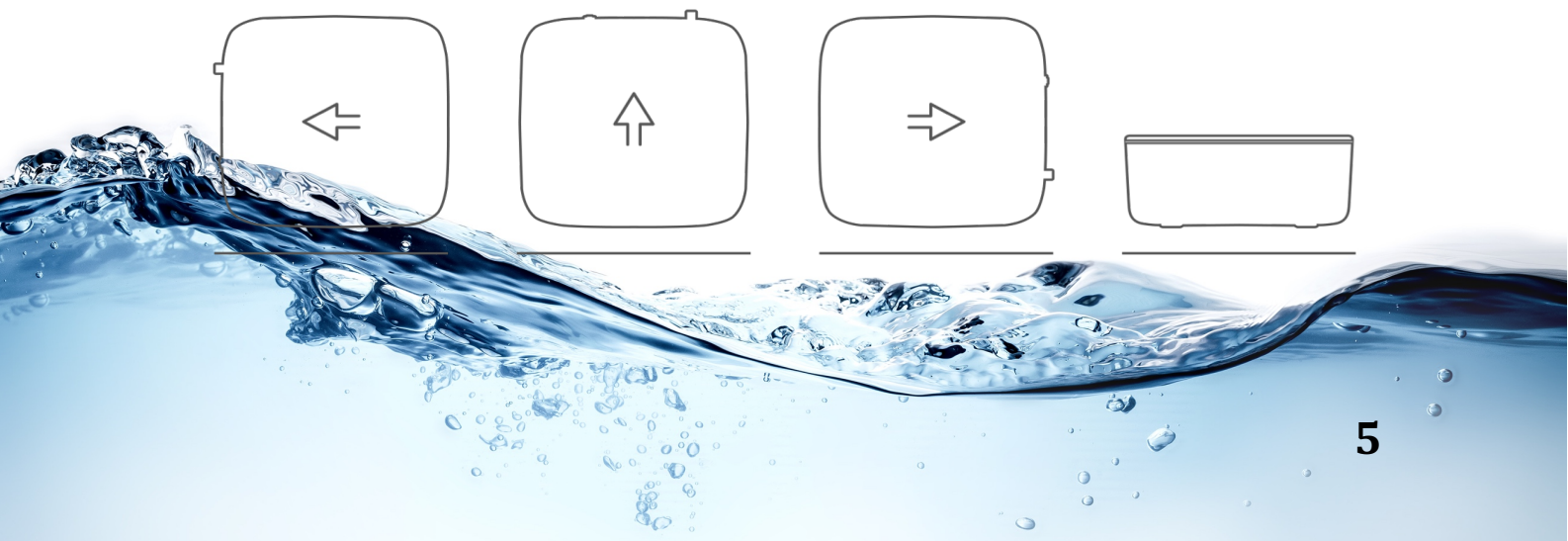

INSTALLATION

För att garantin skall gälla så rekommenderar vi att man installerar en tryckregulator innan osmosen. Detta för att förhindra så att övertryck kan nå osmosen. Ett övertryck kan orsaka vattenläckage och skada på enheten.

Ta bort pluggarna från IN, OUT och DRAIN. Spara dessa för eventuell senare flytt eller nedmontering av produkten.

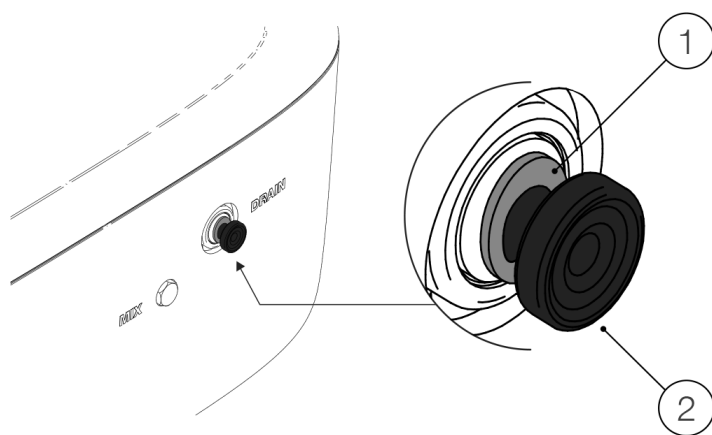
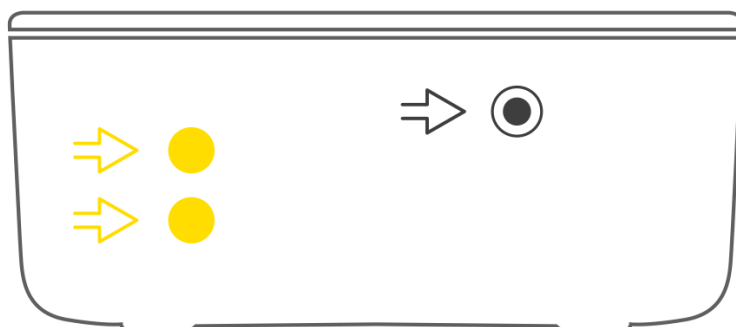

1. Håll spännet intryckt.
2. Ta ut pluggen.



INSTALLATION | AVLOPP



Armbågs- koppling 1/4"	Slang 1/4"	Dränerings- klämma
1 st	Bara nödvändigt	1 st

Montering av dräneringsklämma

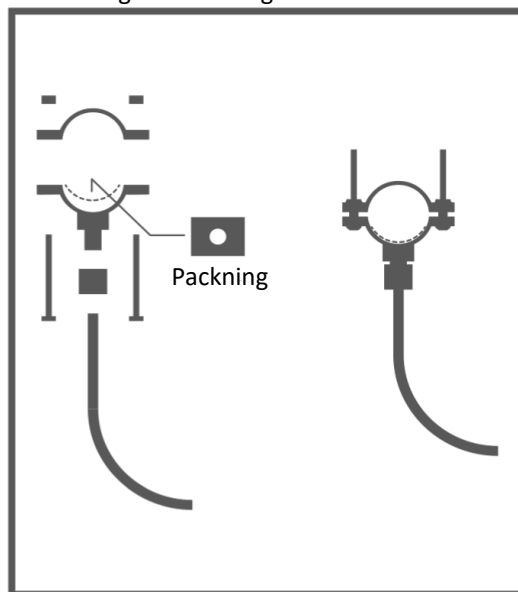

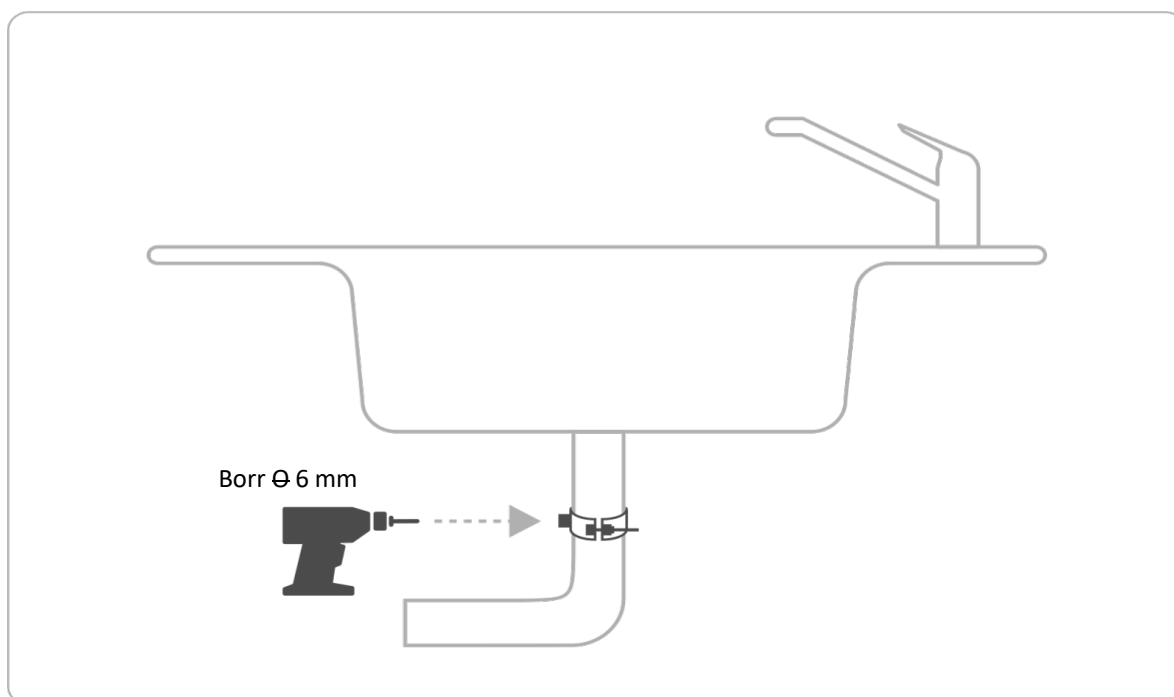
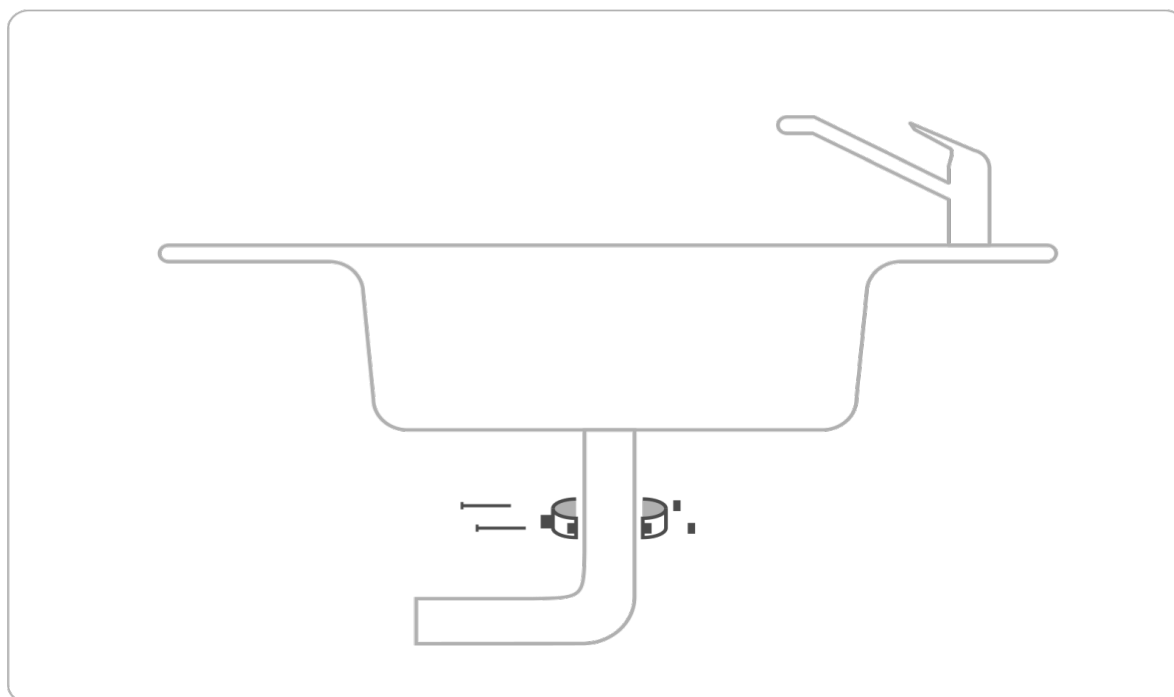

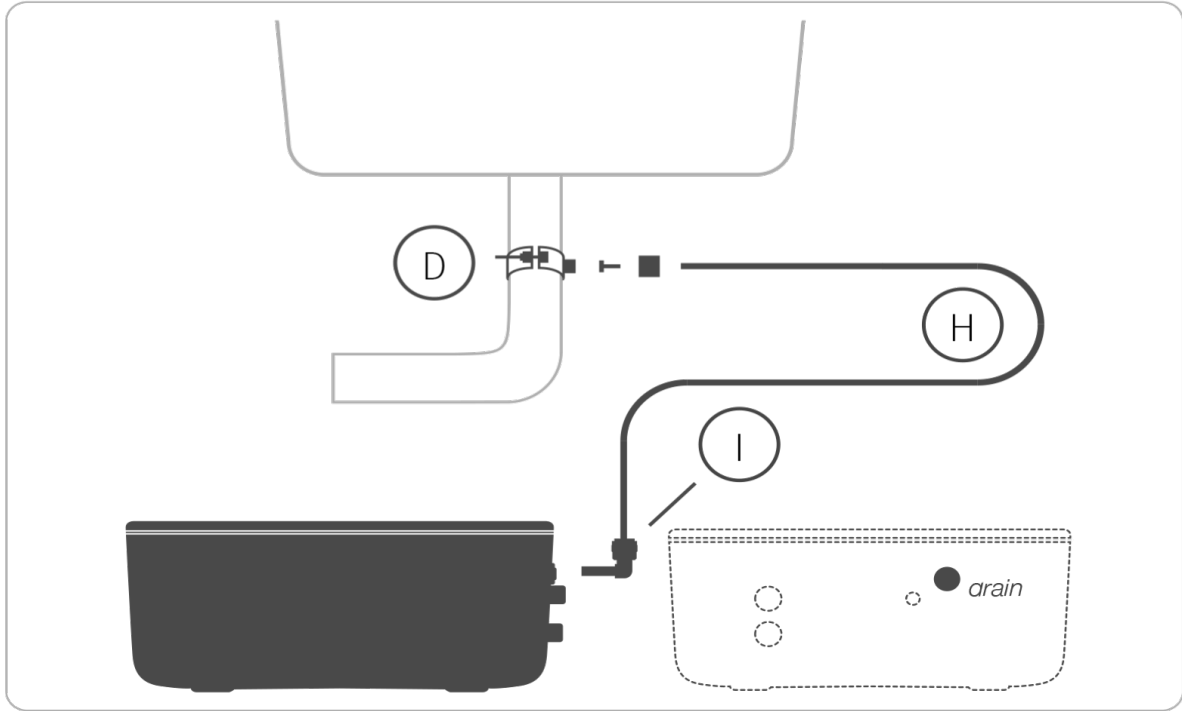

INSTALLATION | INKOMMANDE VATTEN

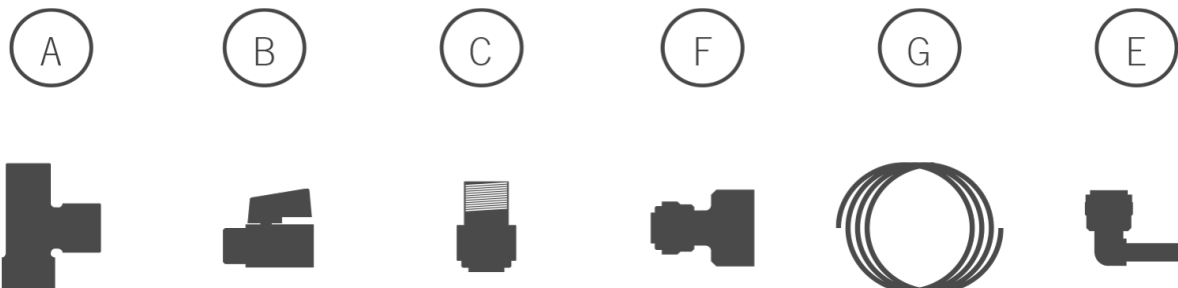

T-koppling	Kulventil	Utvändig rak koppling 3/8"	Invändig rak koppling	Slang 8x6 mm	Armbågskoppling 8 mm
1 st	1 st	1 st	1 st	Bara nödvändigt	2 st





Stäng av kallvattenventilen före installation.

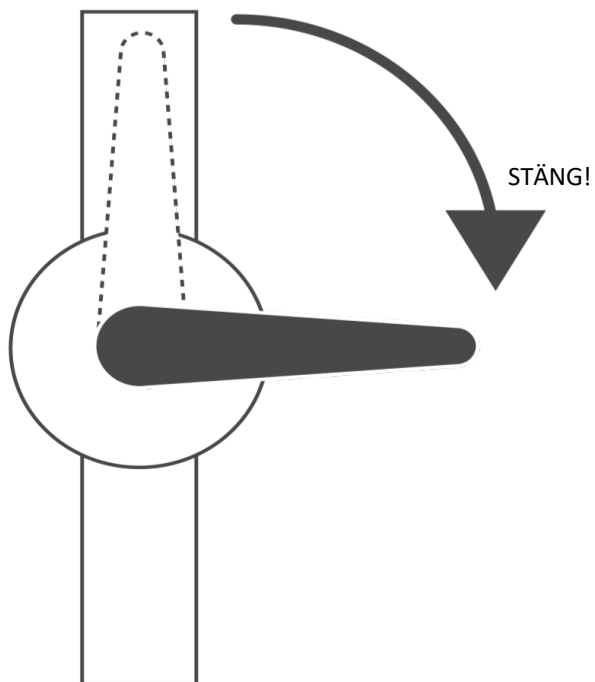

Täck med PTFE gängtejp före installation

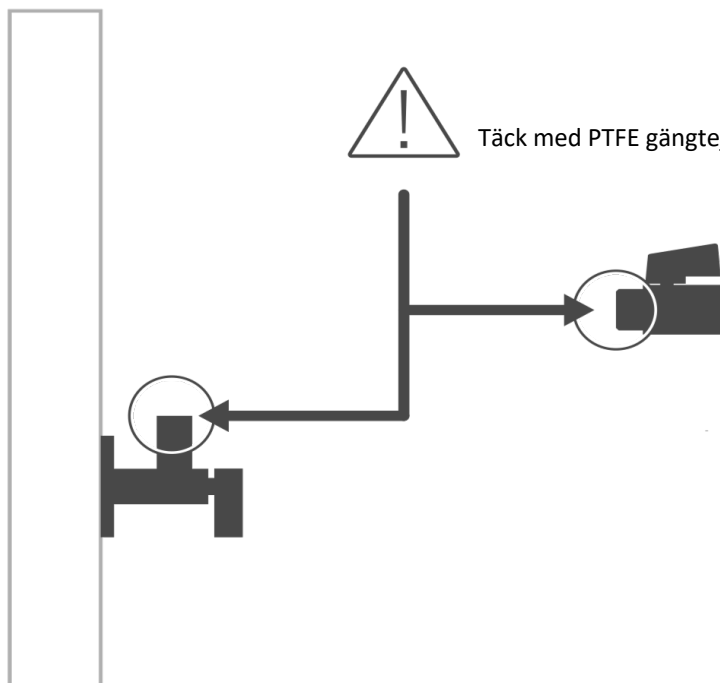

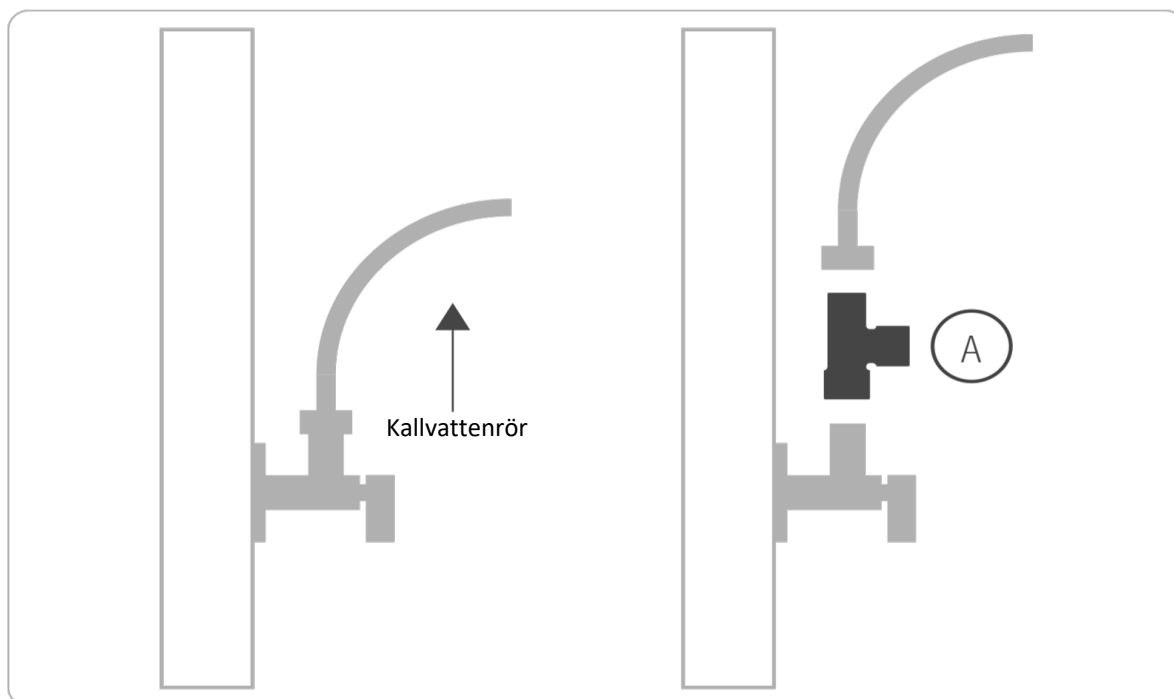

1/4

2/4

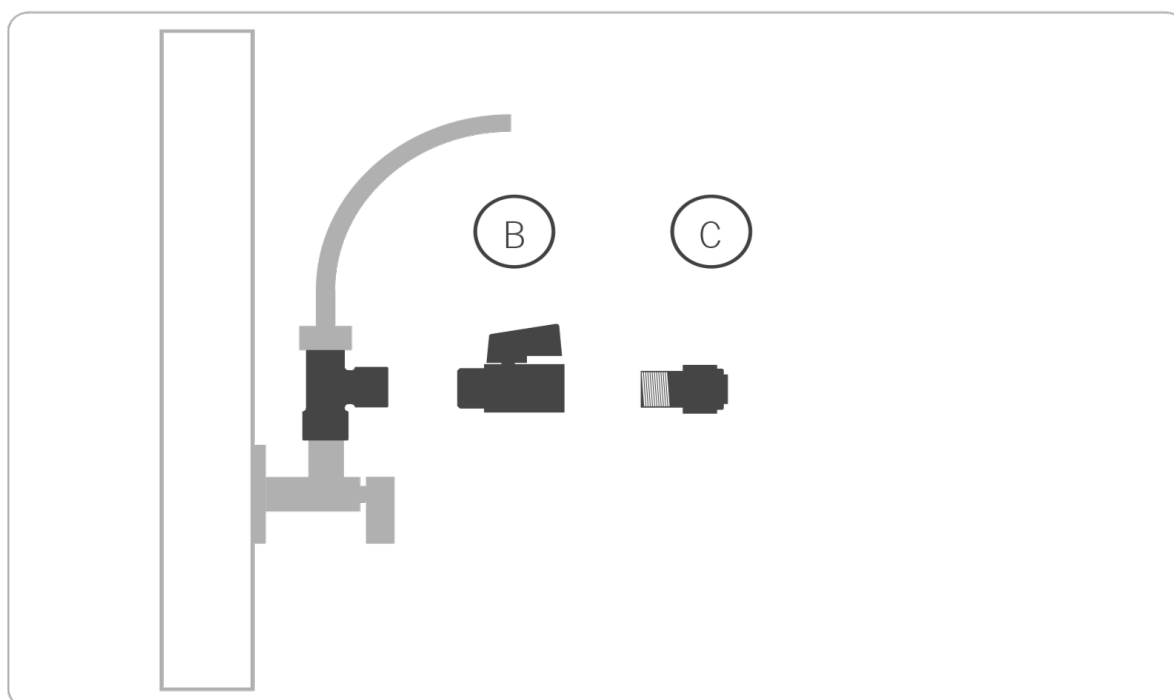

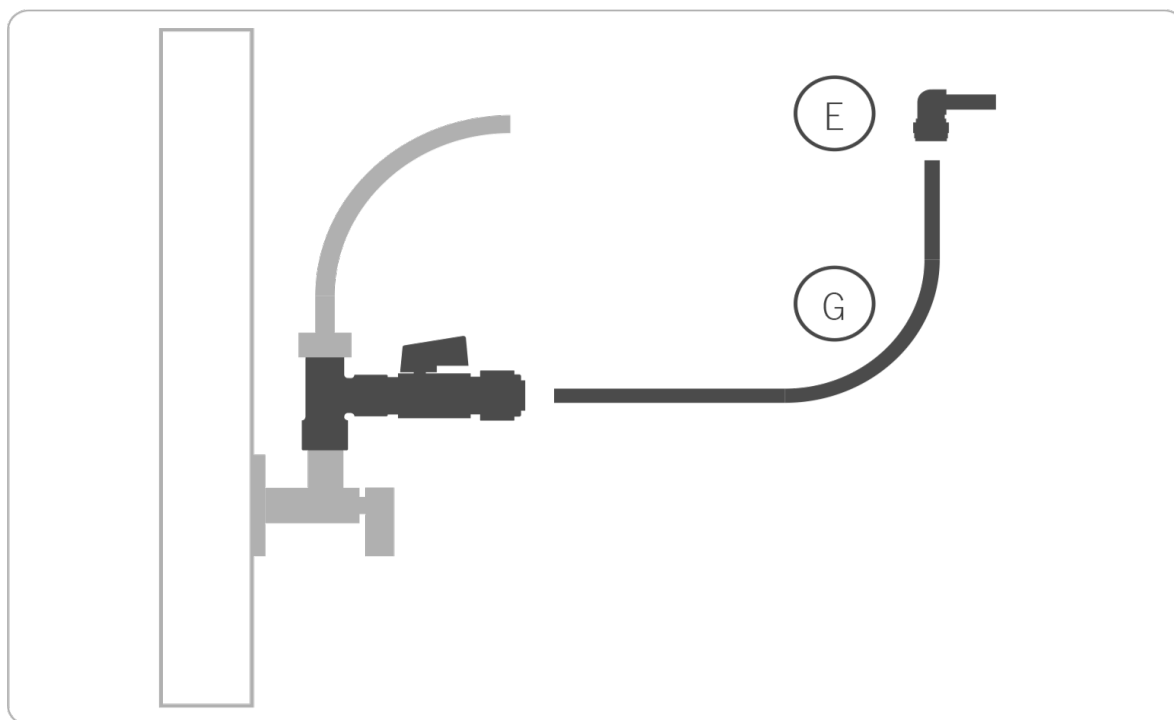

3/4

4/4

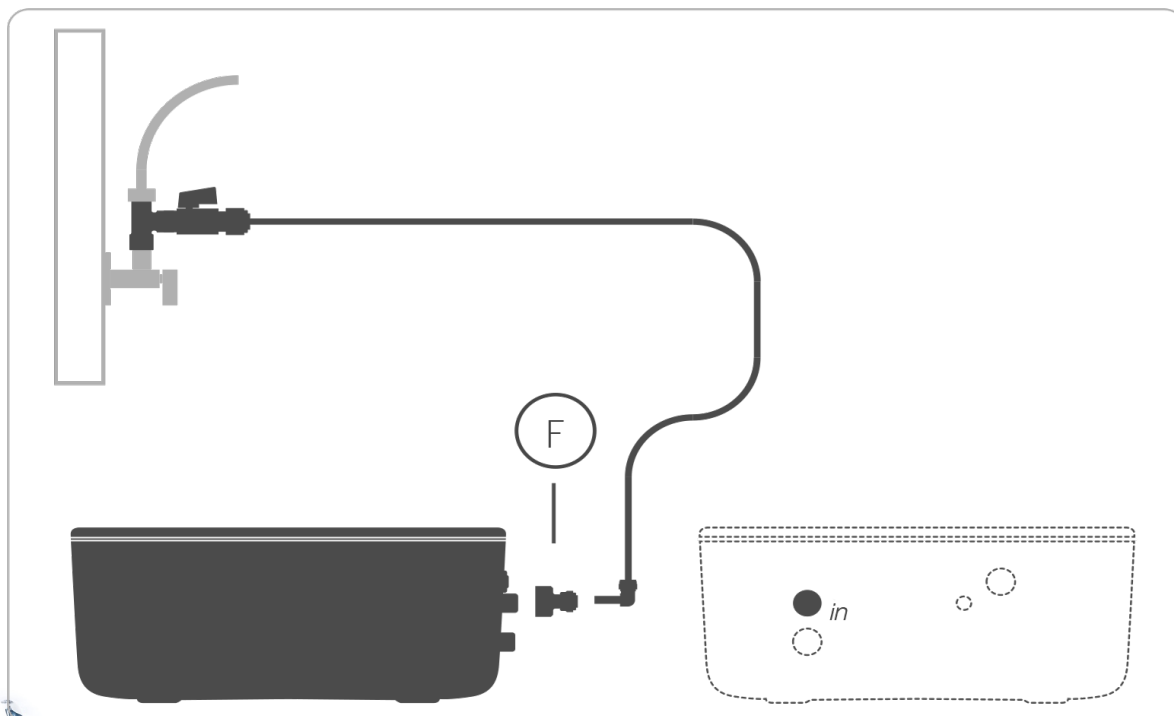

INSTALLATION | KRAN

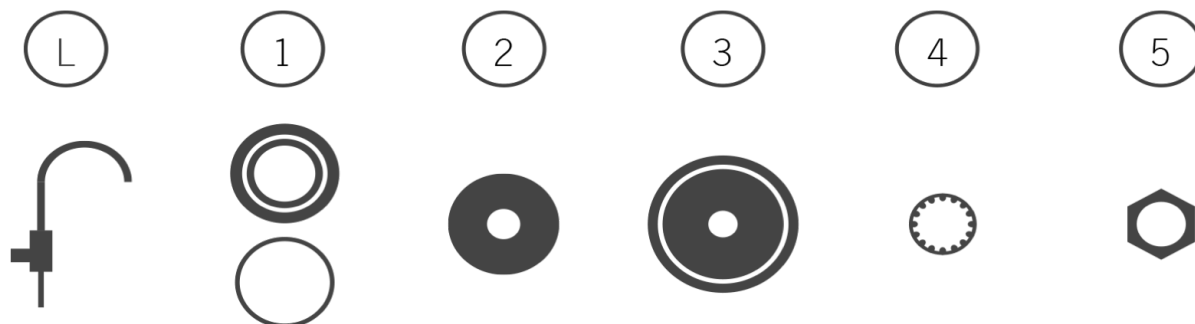

Kran	Distans med o-ring	Gummipackning	Plastbricka	Sågtandad bricka	Mutter
1 st	1+1 st	1 st	1 st	1 st	1 st

Se sida 18 för kranens bruksanvisning.



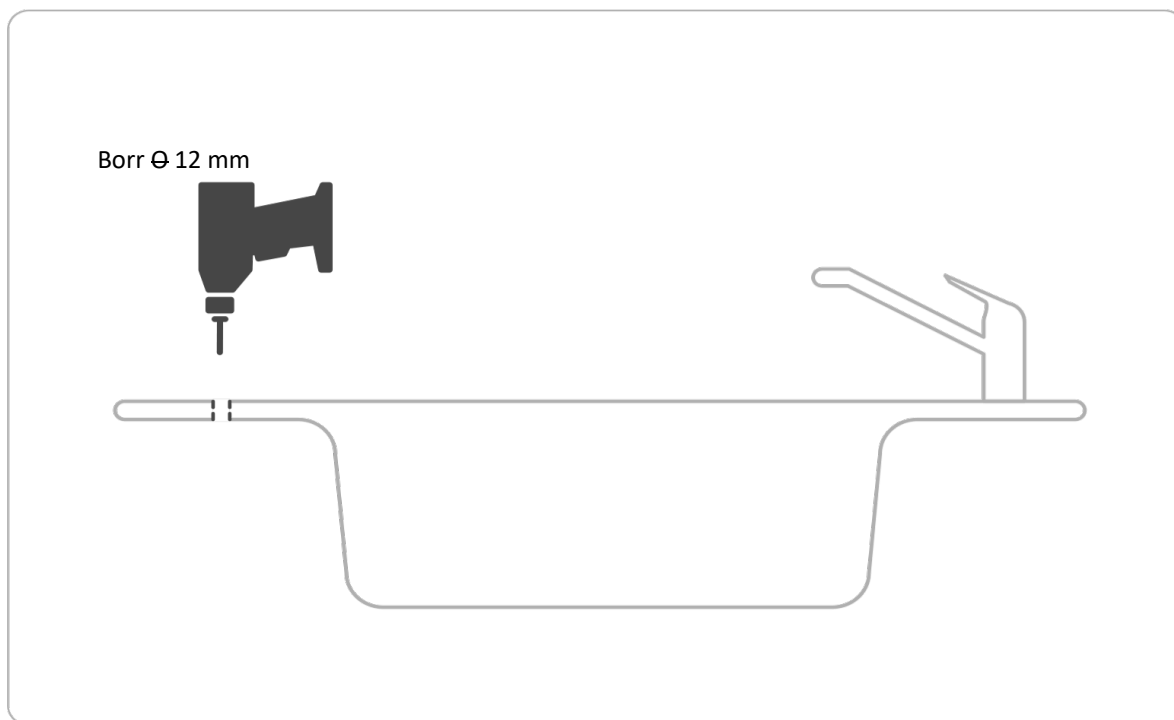

1/2

2/2

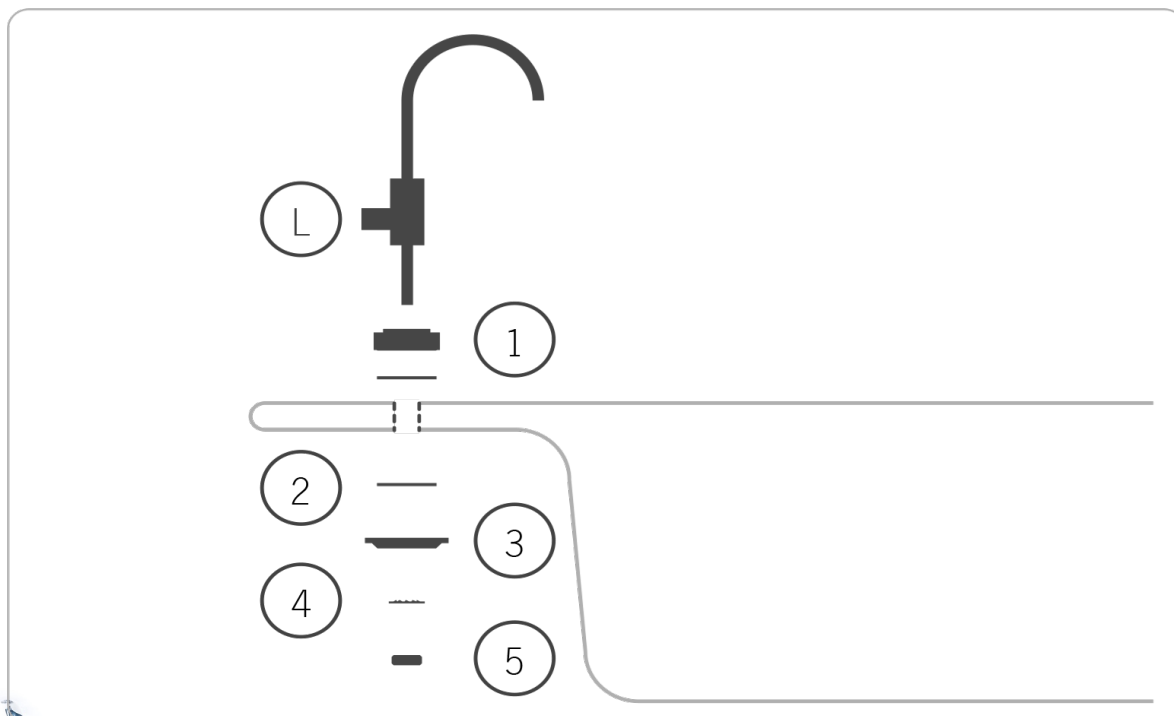

INSTALLATION | MINERALPATRON

Installationskit 6101007481

Mineralpatronen är ett tillval. Gå vidare till "Installation | Utgående vatten" om du ej beställt mineralpatron.



JG Invändig push-in-koppling 3,8" x 3,8"	JG Rak koppling 3,8" x 3,8"	JG Slang LLDPE 3,8" OD x 0,250" ID
1 st	1 st	1 m



INSTALLATION | UTGÅENDE VATTEN



O-ring 3021	Invändig rak koppling	Slang 8x6 mm	Armbågskoppling 8 mm	Invändig rak koppling
1 st	1 st	Bara nödvändigt	1 st	1 st



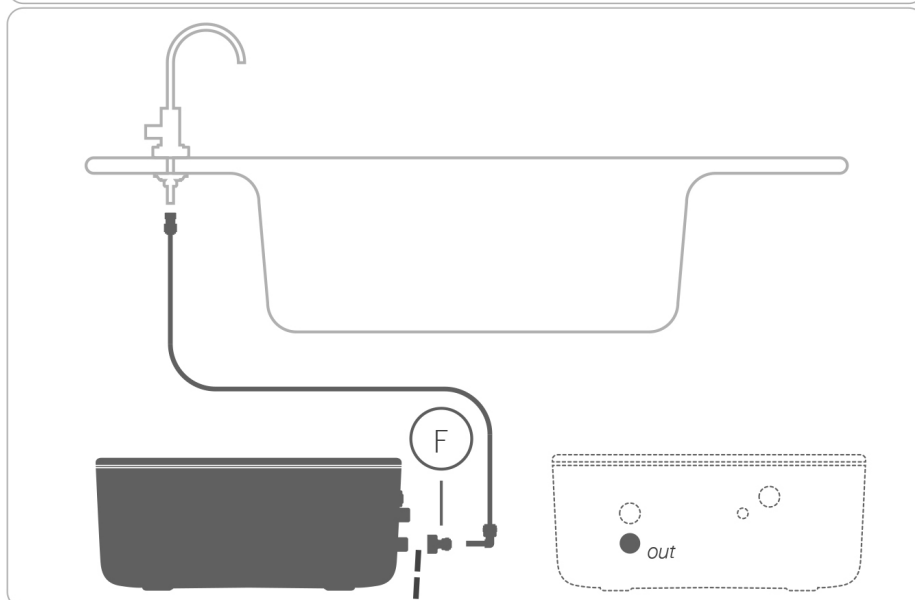
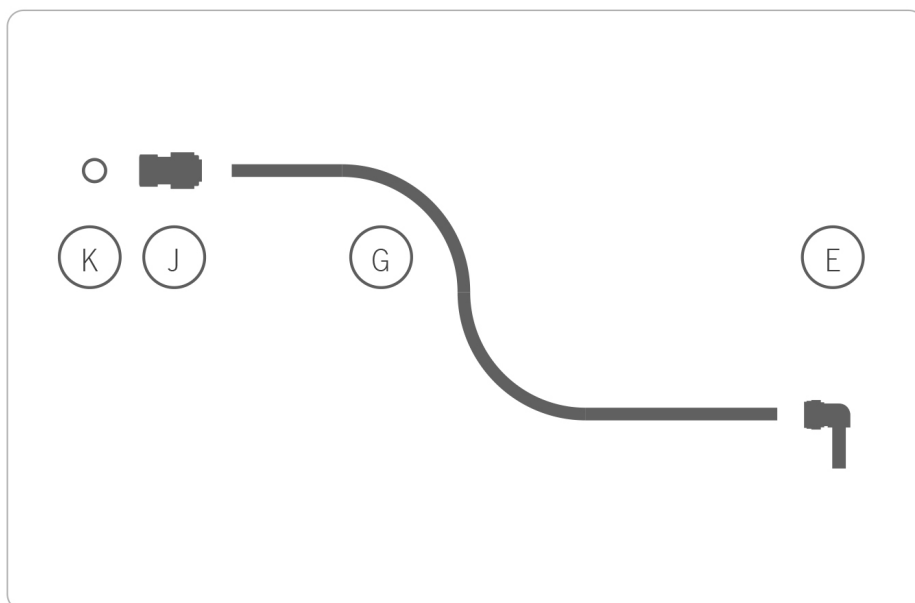

BRUKSANVISNING



Skulle enheten låta under första uppstart skall du göra enligt följande:

1. Placera enheten vertikalt och låt eventuell luft tömmas ur systemet.
2. Utför minst tre påfyllnings- och tömningscykler för att konditionera systemet.
3. Placera enheten horisontellt.

OBS! Ljudet försvinner vanligtvis efter några cykler och/eller efter några timmar.

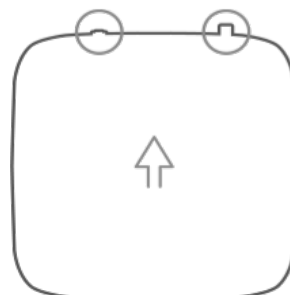

BRUKSANVISNING | BYTE AV FILTERPATRON

1. Börja med att stänga kallvattenkranen och spola sedan vatten tills tanken är tom.

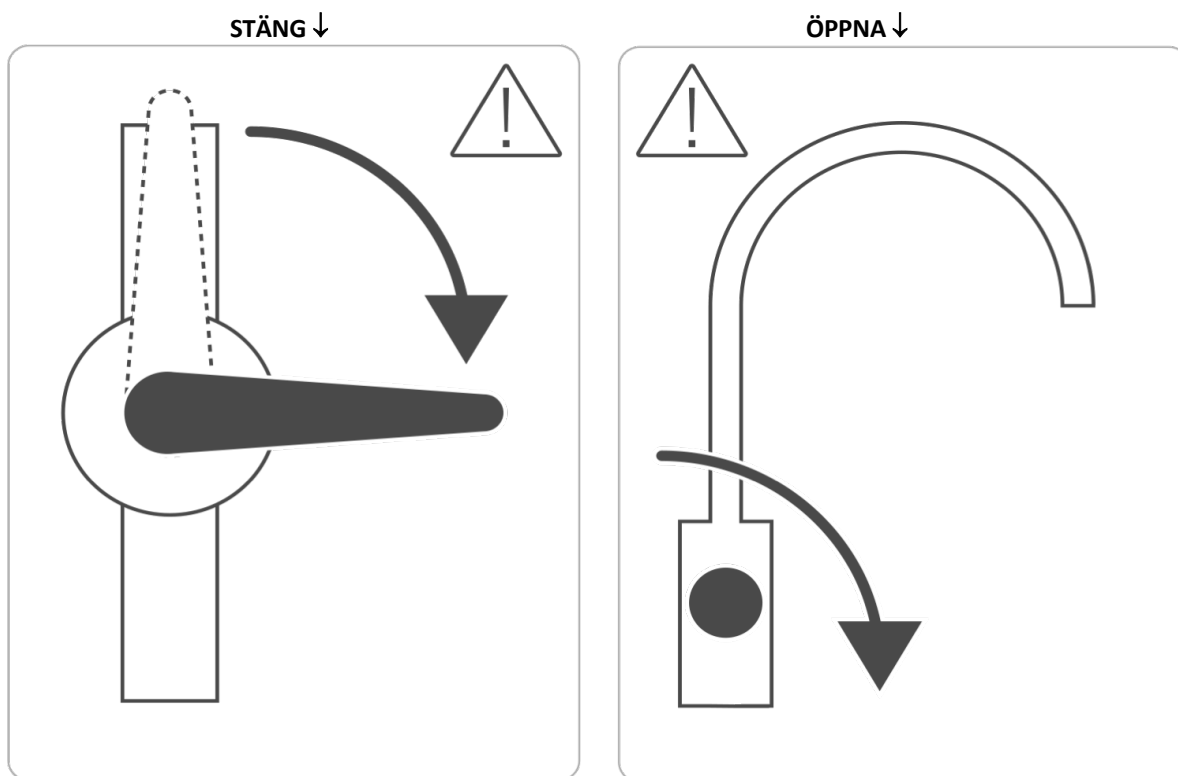

2. Blöt o-ringens innan du sätter i patronen.



3. Lossa den förbrukade filterpatronen genom att först vrida den medsols och sedan ut.
4. Montera den nya filterpatronen genom att först trycka in patronen i hållaren och sedan vrida motsols.

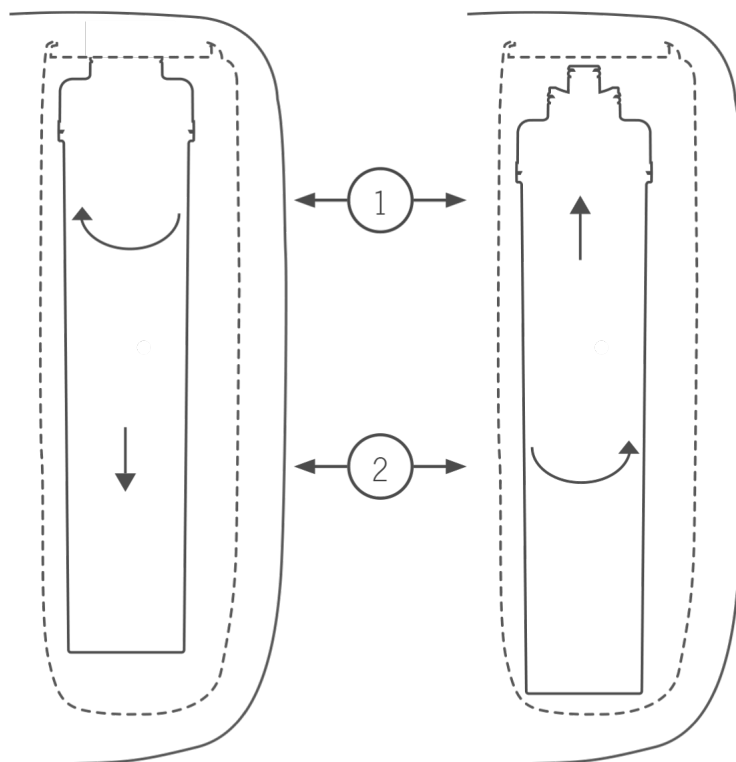

UTBYTESPATRONER, KIT

Y21485B

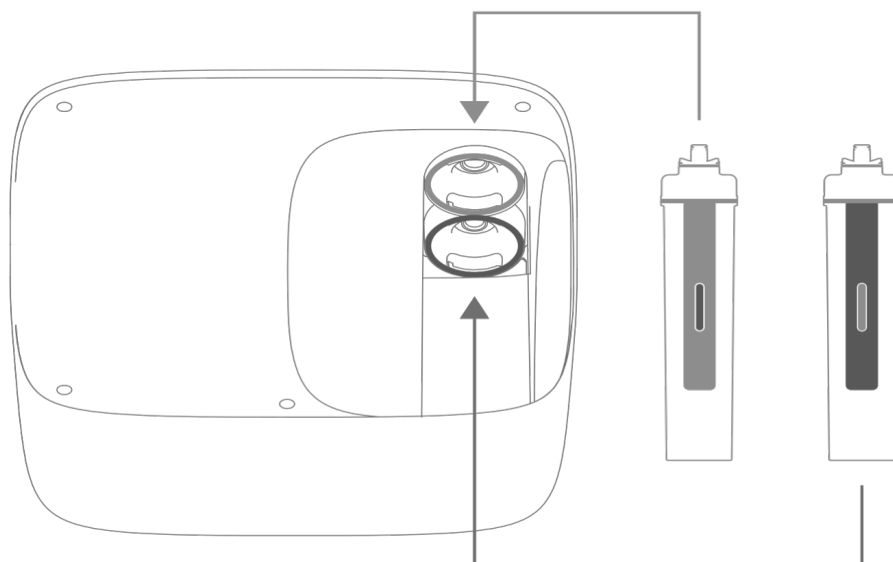
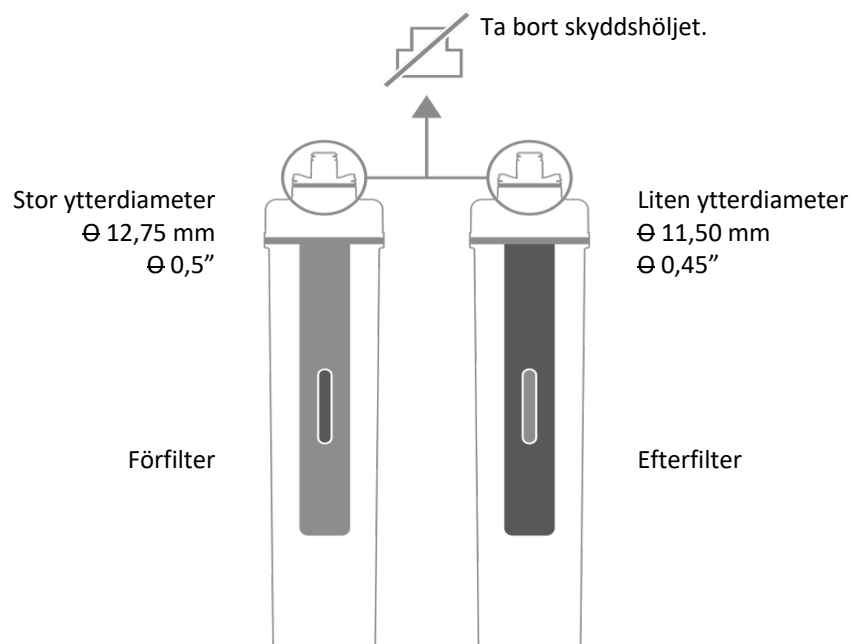

TEKNISKA DATA

Inkommande vattentryck Bar	Kapacitet liter/min.	Återfyllning reservtank Min.
2,5	2,4	15
3	2,7	12
4	3,2	8

Testförhållanden

Temp. Inkommande vatten 15°C
 Avslag >90
 Återvinning (vid 2,5 Bar) 40%

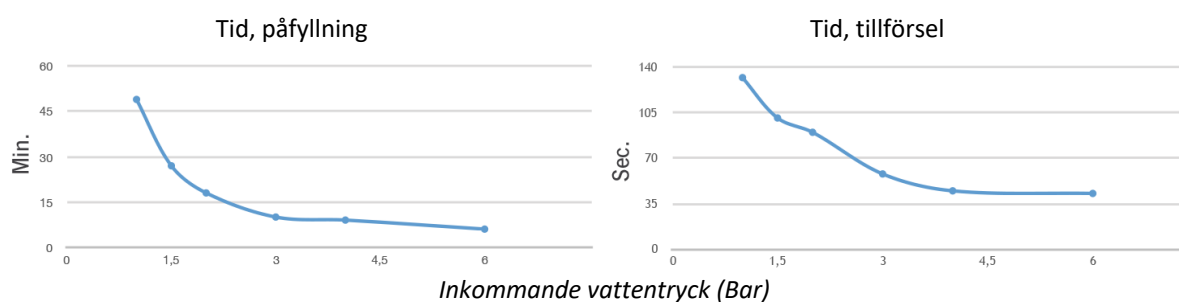

Parameter (bypass av)	Enhet	In	Ut
Konduktivitet (25°C)	mS/m	28,9	1,47
pH		8,15	7,54
Klorid	mg/l	3,1	0,223
Sulfater	mg/l	19,3	0,572
Zink	mg/l Zn	0,0118	Ej mätbart
Kalcium	mg/l Ca	32,4	1,48
Magnesium	mg/l Mg	11,5	0,45
Kalium	mg/l K	0,7	0,176
Natrium	mg/l Na	2,07	0,52
Total fosfor	µg/l P2O5	29,8	Ej mätbart
Krom	mg/l Cr	0,00094	Ej mätbart
Nitrater	mg/l	3,5	2,9

Flödes hastighet 24 l/h (@4 bar)

Arbets tryck min/max 1,5 bar/6 bar

Temperatur min/max 5°C/35°C

KONTAKT

Svensk Vattenanalys AB
0920-255 220
info@svenskvattenanalys.se
www.svenskvattenanalys.se

Midgårdsvägen 3
97334 Luleå